

Plunger Pumps

Please read and save these instructions. Read carefully before attempting to assemble, install, operate or maintain the product described. Protect yourself and others by observing all safety information. Failure to comply with instructions could result in personal injury and/or property damage! Retain instructions for future reference.

Description

This plunger pump will pump up to 2.5 GPM at 2500 PSI. It spins at 3400 RPM in a direct drive system coupled with a gasoline engine. The matching flange provides convenient connection to most 3/4" shaft 1.1 - 5.5 HP engines. The hollow shafted pump includes a built-in pressure control valve, and chemical injection system.

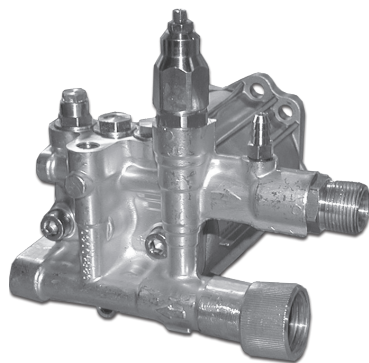

Figure 1 - RMV

RMV 3400 rpm D Version

Model	Max GPM	Max PSI
RMV2G20D	2.0	2000
RMV2G23B	2.0	2300
RMV2G25D	2.0	2500
RMV2.5G20D	2.5	2000
RMV2.5G23B	2.5	2300
RMV2.5G25D	2.5	2500

Special Note: Use only AR64545 for the XJ/SJ/BK/RMV Series pumps only: Do NOT change oil. Use oil only to add if low. This oil is a specially formulated synthetic with special additives for the demands of the XJ, SJ, BK and RMV pump series. No other oil is factory approved for these pumps, and could result in pump failure.

Plunger Pumps

RMV

D version
Hollow shaft pump \varnothing 3/4"

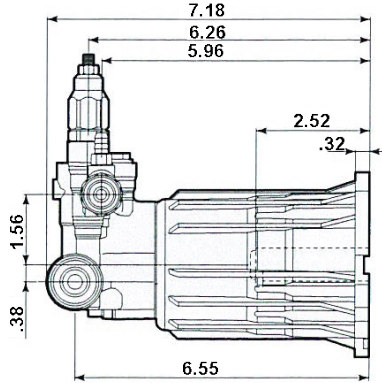
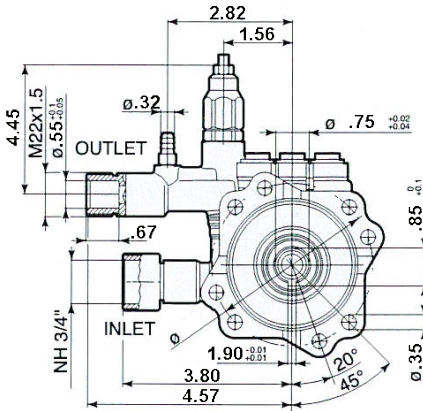

SPRAY NOZZLE CHART

Nozzle #	1000	1200	1400	1600	1800	2000	2200	2400	2600	2800	3000	3200	3400	3600	3700	4000	4200	4400	4600	4800	5000
	PSI	PSI	PSI	PSI	PSI	PSI	PSI	PSI	PSI	PSI	PSI	PSI	PSI	PSI	PSI	PSI	PSI	PSI	PSI	PSI	PSI
2.0	1.00	1.10	1.18	1.26	1.34	1.41	1.48	1.55	1.61	1.67	1.73	1.79	1.84	1.90	1.92	2.00	2.05	2.10	2.14	2.19	2.40
2.25	1.13	1.23	1.33	1.42	1.51	1.59	1.67	1.74	1.81	1.88	1.95	2.01	2.07	2.13	2.16	2.25	2.31	2.36	2.41	2.46	2.52
2.5	1.25	1.37	1.48	1.58	1.68	1.77	1.85	1.94	2.02	2.09	2.17	2.24	2.30	2.37	2.40	2.50	2.56	2.62	2.68	2.74	2.80
2.75	1.38	1.51	1.63	1.74	1.84	1.94	2.04	2.13	2.22	2.30	2.38	2.46	2.54	2.61	2.64	2.75	2.82	2.88	2.95	3.01	3.07
3.0	1.50	1.64	1.77	1.90	2.01	2.12	2.22	2.32	2.42	2.51	2.60	2.68	2.77	2.85	2.89	3.00	3.07	3.15	3.22	3.29	3.35
3.25	1.63	1.78	1.92	2.06	2.18	2.30	2.41	2.52	2.62	2.72	2.81	2.91	3.00	3.08	3.13	3.25	3.33	3.41	3.49	3.56	3.63
3.5	1.75	1.92	2.07	2.21	2.35	2.47	2.60	2.71	2.82	2.93	3.03	3.13	3.23	3.32	3.37	3.50	3.59	3.67	3.75	3.83	3.91
4.0	2.00	2.19	2.37	2.53	2.68	2.83	2.97	3.10	3.22	3.35	3.46	3.58	3.69	3.79	3.85	4.00	4.10	4.20	4.29	4.38	4.47
4.5	2.25	2.46	2.66	2.85	3.02	3.18	3.34	3.49	3.63	3.76	3.90	4.02	4.15	4.27	4.33	4.50	4.61	4.72	4.83	4.93	5.03
5.0	2.50	2.74	2.96	3.16	3.35	3.54	3.71	3.87	4.03	4.18	4.33	4.47	4.61	4.74	4.81	5.00	5.12	5.24	5.36	5.48	5.59
5.5	2.75	3.01	3.25	3.48	3.69	3.89	4.08	4.26	4.43	4.60	4.76	4.92	5.07	5.22	5.29	5.50	5.64	5.77	5.90	6.02	6.15
6.0	3.00	3.29	3.55	3.79	4.02	4.24	4.45	4.65	4.84	5.02	5.20	5.37	5.53	5.69	5.77	6.00	6.15	6.29	6.43	6.57	6.71
6.5	3.25	3.56	3.85	4.11	4.36	4.60	4.82	5.03	5.24	5.44	5.63	5.81	5.99	6.17	6.25	6.50	6.66	6.82	6.97	7.12	7.27
7.0	3.50	3.83	4.14	4.43	4.70	4.95	5.19	5.42	5.64	5.86	6.06	6.26	6.45	6.64	6.73	7.00	7.17	7.34	7.51	7.67	7.83
7.5	3.75	4.11	4.44	4.74	5.03	5.30	5.56	5.81	6.05	6.27	6.50	6.71	6.91	7.12	7.21	7.50	7.69	7.87	8.04	8.22	8.39
8.0	4.00	4.38	4.73	5.06	5.37	5.66	5.93	6.20	6.45	6.69	6.93	7.16	7.38	7.59	7.69	8.00	8.20	8.39	8.58	8.76	8.94
8.5	4.25	4.66	5.03	5.38	5.70	6.01	6.30	6.58	6.85	7.11	7.36	7.60	7.84	8.06	8.18	8.50	8.71	8.91	9.12	9.31	9.50
9.0	4.50	4.93	5.32	5.69	6.04	6.36	6.67	6.97	7.26	7.53	7.79	8.05	8.30	8.54	8.66	9.00	9.22	9.44	9.65	9.86	10.06
9.5	4.75	5.20	5.62	6.01	6.37	6.72	7.05	7.36	7.66	7.97	8.23	8.50	8.76	9.01	9.14	9.50	9.73	9.96	10.19	10.41	10.62
10.0	5.00	5.48	5.92	6.32	6.71	7.07	7.42	7.75	8.06	8.37	8.66	8.94	9.22	9.49	9.62	10.00	10.25	10.49	10.72	10.95	11.18
11.0	5.50	6.02	6.51	6.96	7.38	7.78	8.16	8.52	8.87	9.20	9.53	9.84	10.14	10.44	10.58	11.00	11.27	11.54	11.80	12.05	12.30
12.0	6.00	6.57	7.10	7.59	8.05	8.49	8.90	9.30	9.67	10.04	10.39	10.73	11.06	11.38	11.54	12.00	12.30	12.59	12.87	13.15	13.42
12.5	6.25	6.85	7.40	7.91	8.39	8.84	9.27	9.68	10.08	10.46	10.83	11.18	11.52	11.86	12.02	12.50	12.81	13.11	13.40	13.69	13.98
13.0	6.50	7.12	7.69	8.22	8.72	9.19	9.64	10.07	10.48	10.88	11.26	11.63	11.99	12.33	12.50	13.00	13.32	13.63	13.94	14.24	14.53

Gallons Per Minute



Plunger Pumps

<i>Formulas</i>	<i>Conversions</i>
-----------------	--------------------

Nozzles:

Impact Force (lbs.) = .0526 x GPM x √PSI

Nozzle # = $GPM \times \frac{4000}{\sqrt{PSI}}$

GPM = $Nozzle \# \times \frac{PSI}{\sqrt{4000}}$

PSI = $(GPM/Nozzle \#)^2 \times 4000$

Horse Power:

$\frac{GPM \times PSI}{1714}$ = Hydraulic HP

$\frac{GPM \times PSI}{1457}$ = EBHP

$\frac{EBHP \times 1457}{PSI}$ = GPM

$\frac{EBHP \times 1457}{GPM}$ = PSI

HP loss due to altitude = 3% per 1000 FT above sea level

Pump Speed and Flow:

$\frac{Rated \ GPM}{Rated \ RPM} = \frac{Desired \ GPM}{Desired \ RPM}$

$\frac{Motor \ Pulley \ \varnothing}{Pump \ RPM} = \frac{Pump \ Pulley \ \varnothing}{Motor \ RPM}$

Gallons x 3.785412 = Liters

Gallons x 128 = Oz.

PSI x .06896 = Bar

Bar x 14.5038 = PSI

1 inches = 25.4 millimeters

Liters x .2642 = Gallons (US)

Ft. Lbs. x 1.356 = Newton Meters

Inch Lbs. x .11298 = Newton Meters

Newton Meters x .737562 = Ft. Lbs. (force)

Newton Meters x 8.85 = In. Lbs. (force)

Temperature = $1.8(C^{\circ} + 17.78) = F^{\circ} - .555(F^{\circ} - 32) = C^{\circ}$

1 U.S. Gallon of freshwater = 8.33 lbs.

1 PSI = 2.31 feet of water

1 PSI = 2.04 inches of mercury

1 Foot of water = .433 PSI

1 Foot of water = .885 inches of mercury

1 Meter of water = 3.28 feet of water

Kilograms x 2.2 = Lbs.

General Safety Information

WARNINGS

Gasoline Drive Pumps

 The pump is designed to pump non-flammable or non-explosive fluids.

These pumps are intended to pump clean filtered water only.

 Do not operate in or around an explosive environment.

 Always wear safety glasses or goggles and appropriate clothing.

 Do not alter the pump from the

manufacturers design.

 Do not allow children to operate the pump.

 Never point the high-pressure discharge at a person, any part of the body or animals.

Do not operate gasoline engines in a confined area; always have adequate ventilation.

 Do not exceed the pump specifications in speed or pressure.

 Maximum water temperature is 140°F.

Plunger Pumps

General Safety Information (continued)

All positive displacement plunger pumps must have a safety relief valve installed on the discharge side of the pump, this valve could be either an unloader or regulator and must be of adequate flow and pressure for the pump. (This pump has an unloader already built in).

Adequate protective guards must cover all moving parts. Perform routine maintenance on the pump and components.

Use only components that are rated for the flow and pressure of the pump, this would include hose, fittings, safety valves, spray guns etc.

Special Features

Wet End

Manifold: Forged Brass: Strength and no porosity - long life. Higher hydrostatic pressures - safety. **Unloader:** Integral trap pressure, fixed chemical injector. Simple repair using a cartridge replacement kit. **Bolts:** Three bolts, 6mm grade 8.8.

Valves: Ultra Form Cages: Durable, strong, and long life. **Poppets and Spring:** 303 series stainless steel. **Valve Seat:** Brass with an external sealing o-ring on both inlet and discharge valves. **Valve Caps:** Machined brass for greater strength.

Packing and Plungers: Dual seal system. **High Pressure Packing and Low-Pressure Seals:** "U" cup double lip Buna-N for a good positive seat. **Support and Guides:** Special anti-wear plastic, 1-piece construction to assure proper plunger alignment, maximize packing and seal life and prevent plunger wear and damage. **Plungers:**

Solid hardened stainless steel, strong and durable.

Drive End

Bearings: Oversized ball bearing stabilizes the crankshaft and one needle style thrust bearing absorbs the plunger load and assures long radial plate life.

Crankcase: Precision die-cast, with cooling fins for maximum heat dissipation. The housing retains the crankshaft bearing, oil seal and rear wobble plate bearing support washer.

Crankshaft/Wobble Plate: Precision die-cast to assure proper stroke, duration and alignment.

Oil Seals and O-rings: All are constructed of Buna-N rubber. The oil seals have stainless steel garter springs to assure constant tension on the sealing surface.

Oil Capacity: 2.2 oz.

Ports: Inlet Port: Is supplied with a standard brass garden hose connection with inlet strainer. **Discharge Port:** Is supplied with 3/8" M connection. **Accessory Ports:** All models have a 1/4" F port on the inlet side of the manifold.

Extra Features

Dyno Proven: All pumps are dyno tested to assure the theoretical design meets the actual design.

Valve Design: Each pump series has a valve design that optimizes its highest efficiency.

Wet End Repair: Very simple no special tools required.

Design: Using advanced fluid handling design programs. Overall pump efficiency is increased.

Plunger Pumps

Installation

1. Install the shaft key into the keyway and apply a light coating of anti-seize on the engine shaft and key.
2. Align the two key ways and push the pump completely onto the engine.
3. Install all four (4) bolts and tighten evenly. (See figure 2)
4. Install the appropriate water inlet and discharge fittings.
5. Connect the water supply hose and high-pressure discharge hose/spray gun.
6. Turn on the water supply.
7. Open the spray gun to purge the system of any air.
8. Start the engine.
9. If necessary adjust the engine speed and unloader valve.

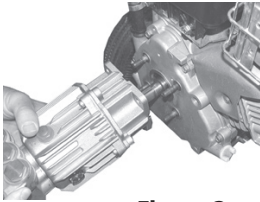

Figure 2

Service Pumps

Servicing the Valves

Discharge Valves: Disassembly:

1. Remove the valve cap (See figure 3).
2. Inspect the valve cap O-ring for any damage, replace if necessary.
3. Using a needle nose pliers remove the valve. (See figure 4)
4. Use a small probe to move the poppet up and down to assure that it is functioning properly.
5. Inspect for any debris that may be lodged between the poppet and seat.
6. Remove the valve seat O-ring and inspect for any damage.



Figure 3

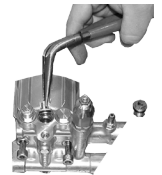

Figure 4

Assembly:

1. Install the valve seat O-ring squarely into the bottom of the manifold. (See figure 5)
2. Insert the valve assembly squarely into the port pushing it into the O-ring.



Figure 5

Plunger Pumps

Service Pumps (Continued)

3. Install the valve cap and torque to the proper specifications. (See figure 6)



Figure 6

Inlet Valves: Disassembly:

1. Remove the manifold.
2. Remove low pressure seals, insert screwdriver under seal lip and lift up. (See figure 7)



Figure 7

3. Using a reversible pliers, carefully remove the packing retainers (plunger guides). (See figure 8)



Figure 8

NOTE: You do not want to damage these so they can be reused if not worn.

4. Remove the high-pressure packing by pulling straight out with your finger. (See figure 9)



Fig-

5. Pull out the valve cage/head ring assembly, valve poppet, spring and O-ring. (See figure 10)

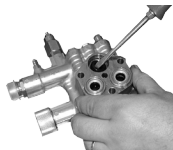

Figure 10

6. Inspect for any debris or damage.
7. Remove the valve O-ring.

Assembly:

1. Install the valve seat O-ring squarely into the bottom of the manifold. (See figure 11)



Figure 11

2. Insert the valve assembly and push squarely into the O-ring. (See figure 12)



Figure 12

3. Install the high-pressure packing by placing it into the cylinder at an angle and then pushing into place.

NOTE: The point of the "V" or flat side of the packing is pointed at you.

4. Lubricate the packing retainer O-ring with a light film of oil and install it into the cylinder.
5. Push it completely into place. (See figure 13)



Figure 13

NOTE: The O-ring will seat just inside the manifold and you will hear a slight pop.

6. Insert the low pressure seal by placing it into the cylinder in at an angle and pushing it into place. (See figure 14)



Figure 14

Plunger Pumps

Service Pumps (Continued)

- Put a thin coat of oil on the plungers and packings. (See figure 15)



Figure 15

- Carefully install the manifold and torque the bolt to the proper specifications. (See figure 16) (See Table C or parts breakdown)

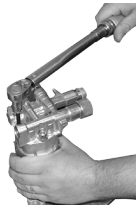

Figure 16

Valve life is dependant on many variables. Hard water, cavitation, corrosion, chemicals and equipment care. The valves are a wear item and need periodic replacement. Worn O-rings or damaged valves will cause pressure loss and pulsations.

Servicing the Packings/Seals

Packings: Disassembly:

To access the water seals for inspection or replacement, you will first need to remove the head of the pump.

NOTE: It is important to make note of the order in which the components of the packing stack are arranged and facing during disassembly.

- Remove the head bolts.
- Insert small pry bars between the head and body at opposite corners and apply pressure down on one pry

bar and up on the other pry bar. (See figure 17)

- Lift the head up and away from the body.

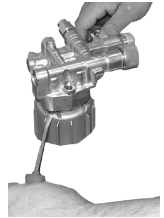

Figure 17

NOTE: The packing stacks will not always stay in the head of the pump when it is removed. Sometimes one or more components of the packing stack will come out of the head and stay on the plunger.

- To remove any components that stay on the plungers simply twist back and forth while pulling up. (See figure 18)



Figure 18

- Remove low pressure seals insert screwdriver under seal lip and lift up. (See Figure 19)

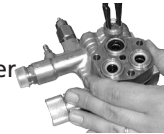

Figure 19

- Remove the piston guides from the head by using a reverse plier (preferably rubber coated) inserted into the center of the piston guide.
- Use a back and forth twisting motion while pulling up (clockwise and counterclockwise).
- Another method is to use a two-prong slide hammer puller. Insert the prongs into the piston guide allowing the prongs to grab under the support ring then use the

Plunger Pumps

Service Pumps (Continued)

slide hammer to pull the packing stack up and out of the head. (See Figure 20)

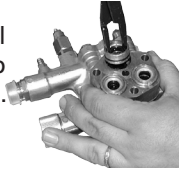

Figure 20

NOTE: Damage to the piston guides and or the seals may occur during removal. Inspect carefully before reusing any components of the packing stack.

9. Remove the high-pressure packing by pulling straight out with your finger. (See Figure 21)



Figure 21

Assembly:

1. Install the high-pressure seal into the head.

NOTE: It should fit snugly. The packing support is part of the valve cage.

2. Place the high-pressure seal at an angle and work it into the cylinder. (See Figure 22)

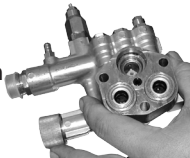

Figure 22

NOTE: The point of the "V" or flat side of the packing is pointed at you.

3. Lubricate the packing retainer O-ring with a light film of oil and

install it into the cylinder. Push it completely into place. (See Figure 23)

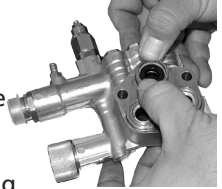

Figure 23

NOTE: The O-ring will seat just inside the manifold and you will hear a slight pop.

4. Insert the low-pressure seal by placing it into the cylinder in at an angle and pushing it into place. (See Figure 24)



Figure 24

5. Put a thin coat of oil on the plungers and packings. (See Figure 25)



6. Carefully install the manifold and torque the bolt to the proper specifications. (See Figure 26)

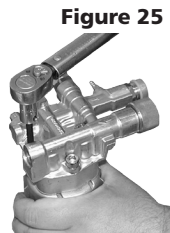

Figure 25

Valve life is dependant on many variables. Hard water, cavitation, corrosion, chemicals and equipment care. The valves are a wear item and need periodic replacement. Worn O-rings or damaged valves will cause pressure loss and pulsations.

NOTE: Water seals are wear items. Life of the seals is dependent on

Fig-

Plunger Pumps

many factors. Water seals should be replaced when water leak or a loss of performance is noticed. Prompt replacement of worn seals will insure peak operating performance and trouble free operation. The water seals and their respective components sometimes referred to as the packing stack, will vary slightly between models. But the constant between models is that the packing stack will consist of the following items:

Piston Guides - which usually house the low-pressure seal

Low-Pressure Seals
Piston Guide O-rings

High-Pressure Seals
Support Rings

Torque Ratings Inch Pounds (ft.lbs.)

Head	221 (19)
Valve Cap	221 (19)

Oil - AR64545 - Container is 4.5 fluid ounces. Specially formulated for the demands of the 5XA48 pump. See parts breakdown.

NOTE: No other oil is factory approved for this pump. Using any other oil may result in Drive End Damage.

Winter or Long Time Storage

1. Drain all of the water out of the pump.

2. Run a 50% solution of a RV or non-toxic/biodegradable antifreeze through the pump.
3. Flush the pump with fresh water before the next use.
4. In freezing conditions failure to do this may cause internal pump damage.
5. For long periods of storage in non-freezing areas the solution will keep the seals and O-rings lubricated.

Troubleshooting

Symptom	Possible Cause(s)	Corrective Action
Oil leak between crankcase and pumping section	Worn rod oil seals	Replace crankcase piston rod seals
Frequent or premature failure of the packing	1 Cracked, damaged or worn plunger	1 Replace plungers
	2 Overpressure to inlet manifold	2 Reduce inlet pressure
	3 Material in the fluid being pumped	3 Install proper filtration on pump inlet plumbing
	4 Excessive pressure and/or temperature of fluid being pumped	4 Check pressures and fluid inlet temperature; be sure they are within specified range
	5 Running pump dry	5 Do not run pump without water
Pump runs but produces no flow	Pump is not primed	Flood suction then restart pump
Pump fails to prime	Air is trapped inside pump	Disconnect discharge hose from pump. Flood suction hose, restart pump and run pump until all air has been evacuated
Pump loses prime, chattering noise, pressure fluctuates	1 Air leak in suction hose or inlet	1 Remove suction line and inspect it for a loose liner or debris lodged in hose. Avoid all unnecessary bends. Do not kink hose
	2 Clogged suction strainer	2 Clean strainer
Low pressure at nozzle	1 Unloader valve is by-passing	1 Make sure unloader is adjusted properly and by-pass seat is not leaking
	2 Incorrect or worn nozzle	2 Make sure nozzle is matched to the flow and pressure of the pump. If the nozzle is worn, replace
	3 Worn packing or valves	3 Replace packing or valves
Pressure gauge fluctuates	1 Valves worn or blocked by foreign bodies	1 Clean or replace valves
	2 Packing worn	2 Replace packing
Low pressure	1 Worn nozzle	1 Replace with nozzle of proper size
	2 Belt slippage	2 Tighten or replace with correct belt

Troubleshooting (cont.)

Symptom	Possible Cause(s)	Corrective Action
Low pressure (cont.)	3 Air leak in inlet plumbing	3 Disassemble, reseal and reassemble
	4 Relief valve stuck, partially plugged or improperly adjusted valve seat worn	4 Clean and adjust relief valve; check for worn or dirty valve seats
	5 Worn packing. Abrasive in pumped in cavitation. Inadequate water	5 Install proper filter suction at inlet manifold must be limited to lifting less than 20 feet of water or 8.5 psi vacuum
	6 Worn inlet, discharge valve blocked or dirty	6 Replace inlet and discharge valve
Pump runs extremely rough, pressure very low	1 Inlet restrictions and/or air leaks.	1 Clean out foreign material
	2 Stuck inlet or discharge valve	2 Replace worn valves
Water leakage from under manifold	Worn packing or cracked plunger	Install new packing or plunger
Slight leak, oil leaking in the area of crankshaft	1 Worn crankshaft seal or improperly installed oil seal o-ring	1 Remove oil seal retainer and replace damaged O-ring and/or seals
	2 Bad bearing	2 Replace bearing
Excessive play in the end of the crankshaft pulley	Worn main bearing from excessive tension on drive belt	Replace crankcase bearing and/or tension drive belt
Water in crankcase	1 Humid air condensing into water inside the crankcase	1 Change oil intervals
	2 Worn packing and/or cracked plunger	2 Replace packing. Replace plunger
Loud knocking noise in pump	1 Cavitation or sucking air	1 Check water supply is turned on
	2 Pulley loose on crankshaft	2 Check key and tighten set screw
	3 Broken or worn bearing	3 Replace bearing

RMV 3400 RPM

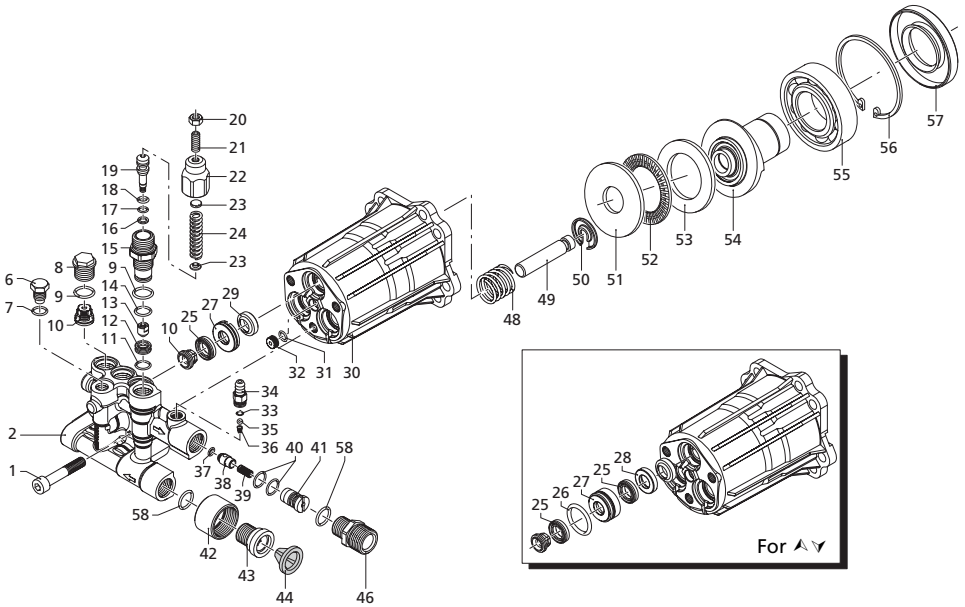

Repair Kits

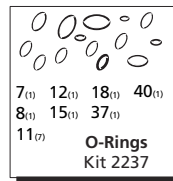
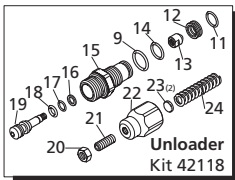

Pos.	Part #	Description	Qty.	Pos.	Part #	Description	Qty.
1	800220	Head bolt M8x45	(221 in/lbs) 3	32	2840710	Oil plug	1
2	2840860	Pump head	○●▽ 1	33	480480	O-Ring ø4.48x1.78	2
3	2840870	Pump head	□▲ 1	34	1982520	Hose nipple	1
6	2840830	Plug	1	35	1250280	Ball	1
7	600180	O-Ring ø7.66x1.78	1	36	1560520	Spring	1
8	2840130	Plug	(221 in/lbs) 3	37	1460430	O-Ring ø4x2.5	1
9	740290	O-Ring ø14x1.7	4	38	2840350	Jet	1
10	2849050	Complete valve	6	39	1343580	Spring	1
11	1470210	O-Ring ø9x1	1	40	800560	O-Ring ø8.73x1.78	2
12	2840770	Seat	1	41	2840340	Detergent injector	1
13	2840760	By-pass jet	1	42	2840270	Suction fitting 3/4" NH	1
14	820510	O-Ring ø10.82x1.78	1	43	2840390	Suction fitting	1
15	2840750	Piston guide	1	44	1266330	Filter	1
16	2760210	Ring	1	46	2840400	Outlet fitting	1
17	660190	O-Ring ø6.07x1.78	1	48	2840060	Spring	3
18	2260100	O-Ring ø6.02x2.62	1	49	2840530	Piston	3
19	2760400	Piston	1	50	2840050	Ring	3
20	1980300	Nut M6	1	51	1980130	Thrust washer	1
21	392840	Grub screw M6x16	1	52	1980250	Bushing	1
22	2760480	Handle insert	1	53	1980240	Thrust washer	1
23	1980220	Plate spring	2	54	2840900	Hollow shaft	○□▲ 1
24	2760410	Spring	1	54	2840730	Hollow shaft	●■▽ 1
25	2200141	Gasket	6	55	161060	Bearing	1
26	770590	O-Ring ø23.52x1.78	▲▽ 3	56	161050	Circlip øi72	1
27	2840561	Bushing	○□ 3	57	2840310	Seal	1
27	2840090	Bushing	●■ 3	58	2840890	O-Ring ø14x2	2
27	2840550	Bushing	▲▽ 3				
28	2840540	Bushing	▲▽ 3		AR64545	Oil	1
29	1683500	Seal	3		OIL CAPACITY 2.2 OZ		
30	2840230	Housing	1				
31	480560	O-Ring ø6.75x1.78	1				

Legend

ø 12	ø 12	ø 12	ø 12
For ○	For ●	For □	For ■
RMV2G20	RMV2.5G20	RMV2G23B	RMV2.5G23B
For ▲	For ▼		
RMV2G25	RMV2.5G25		

Plunger Pumps

Torque Specifications in/lbs:(ft/lbs)

	Oil Capacity	Manifold (Head)	Piston Nut	Rear Cover	Side Cover	Valve Cap	Connecting Rods
RMV	2.2	221(19)	N/A	221/(19)	N/A	221(19)	N/A

LIMITED WARRANTY

Annovi Reverberi (A.R.) Cam Shaft Plunger Pumps are warranted for a period of five years and Axial Radial Pumps are warranted for a period of one year to the original purchaser. Electric Pressure Washers are warranted for a period of one year to the original purchaser. This is from the date shipped from factory or U.S. Warehouse. **AR, ArrowLine** and **GF** accessories are warranted for a period of 90 days.

Warranty covers manufacturing defects or workmanship; that may develop under normal use and service in a manner up to the directions and usage recommended by the manufacturer.

Warranty does not apply to misuse or when pump or accessory is altered or used in excess of recommended speeds, pressures, temperatures or handling fluids not suitable for pump or accessory material construction. Warranty does not apply to normal wear (*such as but not limited to: seals/packings, valves, plungers and sealing o-rings*), freight damage, freezing damage or damage caused by parts or accessories not supplied by AR North America, Inc.

Liability of manufacturer for warranty is limited to repair or replacement of parts only at the option of the manufacturer when such products are found to be of original defect or workmanship at the time it was shipped from factory. This warranty is in lieu of all other warranties, expressed or implied, including any warranty of merchantability and of any and all other obligations or liabilities on the part of the manufacturers or equipment.

WARRANTY RETURNS

Items returned for warranty consideration must have a **Returned Merchandise Authorization (RMA)** number. All unauthorized returns will be refused and shipped back to sender. Please fax requests to: 763-398-2009 or e-mail to shop@arnorthamerica.com.